



feeney® 

DesignRail® Kits

Modular Aluminum Railing Kits



Feeney[®] makes it easy

Create beautiful railings inside and out with DesignRail[®] Kits.
Installation is fast and easy with our modular kits and CableRail stainless steel infill.



Creating your railing is easy!

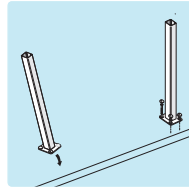

Install Posts

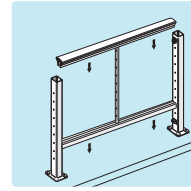

Assemble &
Attach Rail Kits

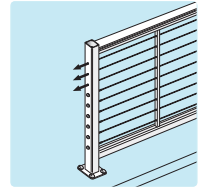

Install CableRail

Kits Overview

PAGE

4

Learn how the kits fit together to create a complete railing project.

Post Kits

PAGE

6

Pre-trimmed and pre-drilled for fast mounting.

Rail Kits

PAGE

7

Designed to run between the posts, for both stair and level railings.

Tools & Accessories

PAGE

8

All the tools and items you need for installing and finishing.

Design your own railing

All our rail and post kits feature 6000 series aluminum and AAMA-2604 powder coated finishes for long lasting beauty and durability, and are available for 36-in and 42-in high railings. Your railing system will require specific quantities and types of kits and parts depending on the configuration of your project.

Rail Kits

- LR** Level Rail Kit
- SR** Stair Rail Kit

Level Post Kits

- IN** Intermediate Post Kit
- TT** Threaded Terminal Post Kit
- QC** Quick-Connect® Post Kit
- SC** Single Corner Post Kit
- NR** Newel Termination Post Kit (Right)
- NL** Newel Termination Post Kit (Left)
- NP** Newel Passthrough Post Kit

Stair Post Kits

- INS** Intermediate Stair Post Kit
- TTS** Threaded Terminal Stair Post Kit
- QCS** Quick-Connect® Stair Post Kit

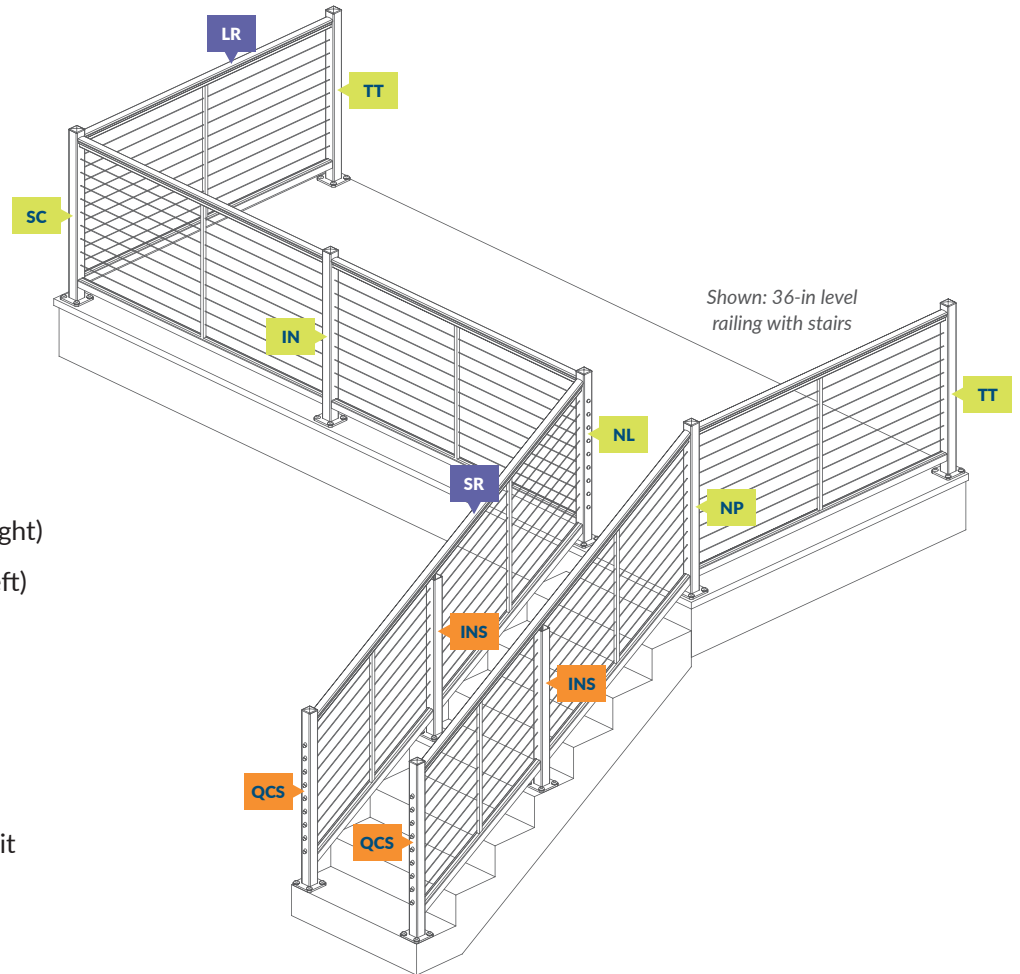

Transitioning to Stairs

with a Newel Passthrough post

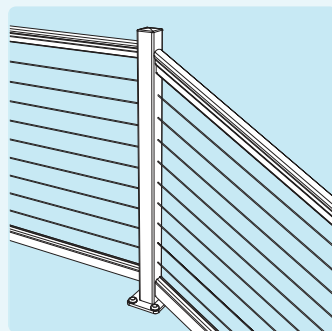

36-IN RAILINGS



42-IN RAILINGS

Terminate the top two cable runs because of the change in height.

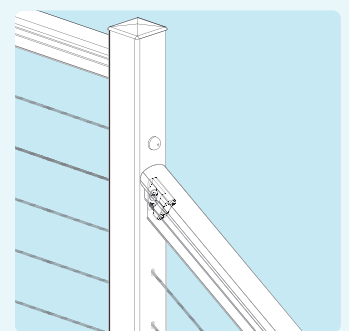

Sample Project

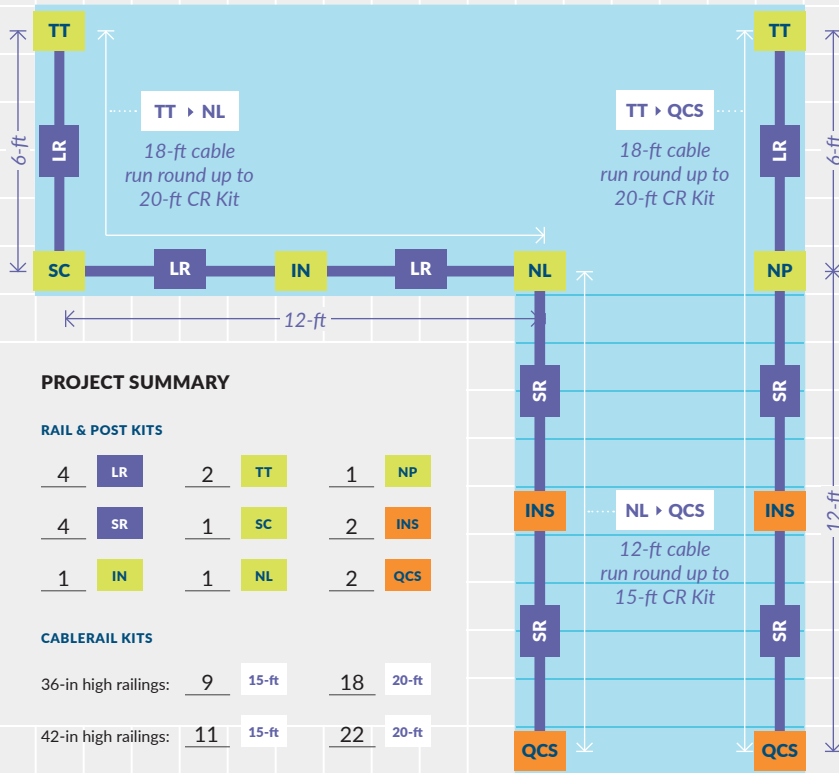

PROJECT SUMMARY

RAIL & POST KITS

4	LR	2	TT	1	NP
4	SR	1	SC	2	INS
1	IN	1	NL	2	QCS

CABLERAIL KITS

36-in high railings:	9	15-ft	18	20-ft
42-in high railings:	11	15-ft	22	20-ft

INSTALLATION TIPS

- Position posts 3 to 3¼-in away from a wall for easier installation of cables
- Max. 6-ft between major posts (Quick-Connect®, Threaded Terminal, Intermediate, and Newel posts)
- Use an intermediate picket (included in the Rail Kit) at least every 3-ft to reduce cable deflection
- Use end caps (sold separately) for a finished look
- Use beveled washers (sold separately) on the cable end fittings to create a flat bearing surface on stairs
- Use Rail Cut Kits (sold separately) if you are dividing the Rail Kits to create multiple shorter length rails
- Use isolation bushings (sold separately) in each post when installing in a harsh environment, such as near salt water

Design Your Project

STEP 1: SKETCH YOUR LAYOUT

STEP 2: SELECT YOUR HEIGHT — 42-IN — 36-IN

STEP 3: SELECT YOUR RAIL & POST KITS

___	LR	___	NR
___	SR	___	NL
___	IN	___	NP
___	TT	___	INS
___	QC	___	TTS
___	SC	___	QCS

STEP 4: SELECT YOUR CABLERAIL KITS

Use 9 CableRail Kits per run for 36-in systems and 11 for 42-in. systems.

___	5-ft	___	25-ft
___	10-ft	___	30-ft
___	15-ft	___	40-ft
___	20-ft	___	50-ft

Post Kits

Each Post Kit includes a post with a pre-attached base plate, a post cap, and mounting screws with caps. All posts come pre-drilled for the cable fittings or for cables to pass through, and can accommodate isolation bushings when required. Stair posts are pre-drilled at an angle to accommodate a stair slope of between 29 and 34 degrees. Level Post Kits are available for railings in two heights: 36-in with 9 cable holes, or 42-in with 11 cable holes. Stair Post Kits are available for 36-in stair railings. Isolation bushings are recommend for installations in harsher climates, such as areas near salt water.

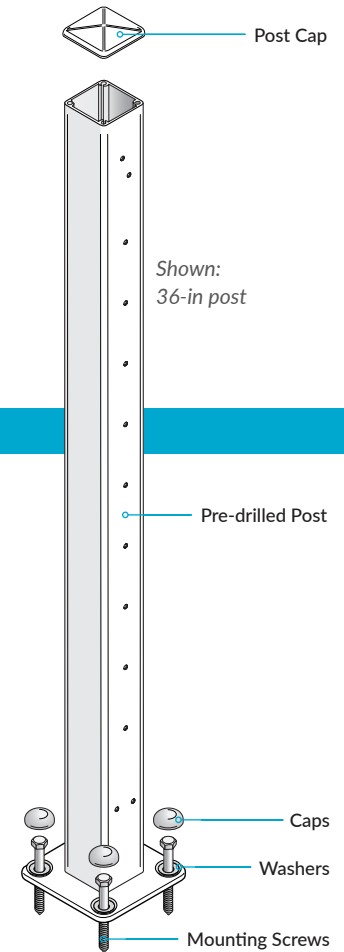

DESIGN NOTE:
Use Feeney Base Plate Covers (sold separately) for a more finished look. See back cover for more information.

LEVEL POSTS

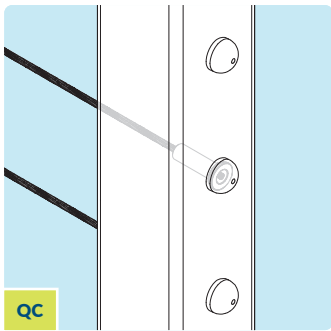

QUICK-CONNECT® END POST KIT

Pre-drilled for CableRail Quick-Connect® end fittings.

AVAILABLE

- 36-in (#7613 BLK-PKG)
- 36-in (#7613 TBLK-PKG)
- 42-in #7618 BLK-PKG)
- 42-in #7618 TBLK-PKG)

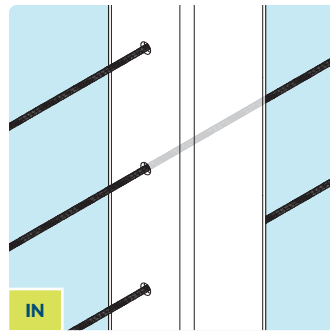

INTERMEDIATE POST KIT

Pre-drilled for cable to pass through.

AVAILABLE

- 36-in (#7611 BLK-PKG)
- 36-in (#7611 TBLK-PKG)
- 42-in (#7616 BLK-PKG)
- 42-in (#7616 TBLK-PKG)

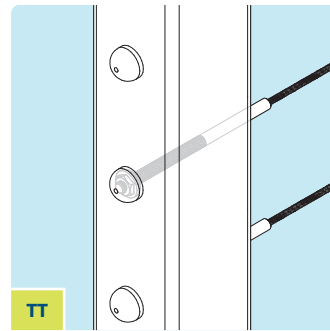

THREADED TERMINAL END POST KIT

Pre-drilled for CableRail Threaded Terminal end fittings.

AVAILABLE

- 36-in (#7612 BLK-PKG)
- 36-in (#7612 TBLK-PKG)
- 42-in (#7617 BLK-PKG)
- 42-in (#7617 TBLK-PKG)

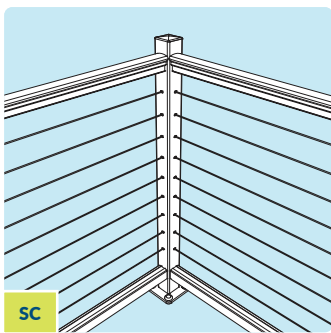

SINGLE CORNER POST KIT

Specially designed for use at corners. Pre-drilled for CableRail to run continuously through the post.

AVAILABLE

- 36-in (#7624 BLK-PKG)
- 36-in (#7624 TBLK-PKG)
- 42-in (#7720 BLK-PKG)
- 42-in (#7720 TBLK-PKG)



NEWEL TERMINATION POST KIT RIGHT

Designed for level to stair railing transitions that have a right 90 degree turn from the stairs. Use Quick-Connect® fitting in level holes and Threaded Terminal fitting in angled holes.

AVAILABLE

- 36-in (#7598 BLK-PKG)
- 36-in (#7598 TBLK-PKG)
- 42-in (#7721 BLK-PKG)
- 42-in (#7721 TBLK-PKG)

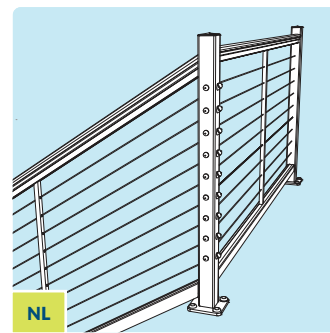

NEWEL TERMINATION POST KIT LEFT

Designed for level to stair railing transitions that have a left 90 degree turn from the stairs. Use Quick-Connect® fitting in level holes and Threaded Terminal fitting in angled holes.

AVAILABLE

- 36-in (#7599 BLK-PKG)
- 36-in (#7599 TBLK-PKG)
- 42-in (#7722 BLK-PKG)
- 42-in (#7722 TBLK-PKG)

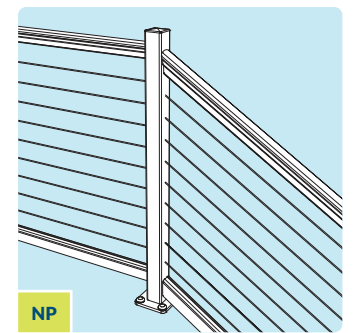

NEWEL PASSTHROUGH POST KIT

Designed for level to stair railing transitions where cables continue through.

AVAILABLE

- 36-in (#7600 BLK-PKG)
- 36-in (#7600 TBLK-PKG)
- 42-in (#7723 BLK-PKG)
- 42-in (#7723 TBLK-PKG)

FRAME COLORS

TEXTURED BLACK (TBLK)

BLACK MATTE (BLK)

STAIR POSTS

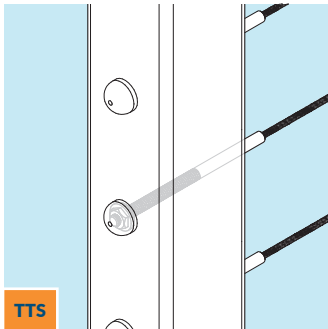

THREADED TERMINAL STAIR END POST KIT

Pre-drilled for CableRail
Threaded Terminal end fittings.

AVAILABLE
36-in (#7614 BLK-PKG)
36-in (#7614 TBLK-PKG)

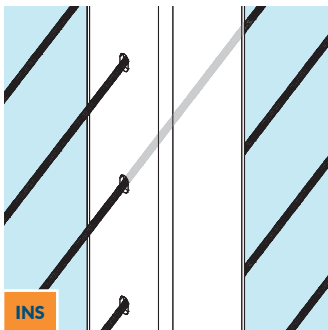

INTERMEDIATE STAIR POST KIT

Pre-drilled for cable to pass through. Includes a post adapter for connecting two Stair Rail Kits.

AVAILABLE
36-in (#7619 BLK-PKG)
36-in (#7619 TBLK-PKG)

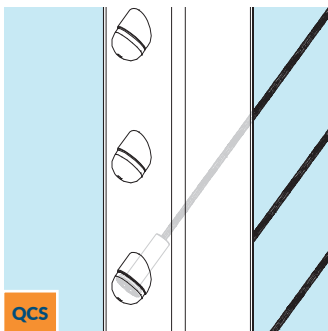

QUICK-CONNECT® STAIR END POST KIT

Pre-drilled for CableRail
Quick-Connect® end fittings.

AVAILABLE
36-in (#7615 BLK-PKG)
36-in (#7615 TBLK-PKG)



Full product details and installation instructions can be found on our website feeneyinc.com/designrail

Rail Kits

Rail Kits contain the rails that run between the posts. Each kit includes a 6-ft top and bottom rail, a pre-drilled intermediate picket, and all necessary attachment hardware. Top and bottom rails can be trimmed to exact length and stair slope in the field. Use Rail Cut Kits if cutting a single Rail Kit for use in multiple smaller sections. Rail Kits can be used with DesignRail® Post Kits or between your own wood posts.

Shown: 36-in Rail Kit

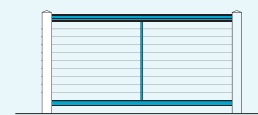
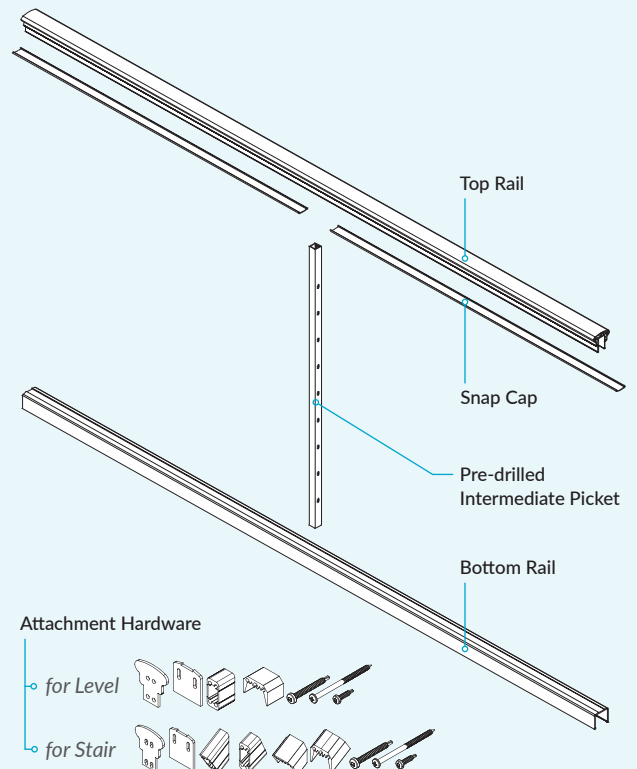

LR

LEVEL RAIL KIT

AVAILABLE
36-in #7724 BLK-PKG)
36-in (#7724 TBLK-PKG)
42-in (#7609 BLK-PKG)
42-in (#7609 TBLK-PKG)

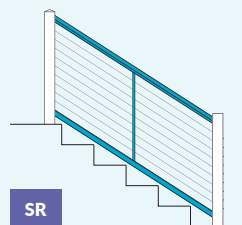

SR

STAIR RAIL KIT

AVAILABLE
36-in (#7610 BLK-PKG)
36-in (#7610 TBLK-PKG)

Tools & Accessories

Find the tools and accessories you need to complete your aluminum railing.



BASE PLATE COVERS

These easy to install 2 piece covers conceal the lag screw heads and post base plates to give the railing a beautiful finishing touch. Great for retrofitting existing DesignRail® installations too.

(#7737 BLK-PKG)

(#7737 TBLK-PKG)



ISOLATION PAD

High density neoprene pads that protect posts and base plates from chemical corrosion that may be caused by contact with concrete or pressure treated wood surfaces.

(#7025-PKG)



LACING NEEDLE

For quickly lacing cable ends through posts without snagging. (#3221-PKG)



CURVED LACING NEEDLE

For quickly lacing cable ends through Single Corner posts. (#3221-CURVE-PKG)



TOUCH-UP PAINT

Color matched to help cover small abrasions. (#7250-BB-PKG)

⚠️WARNING: Cancer and Reproductive Harm - www.P65Warnings.ca.gov



RAIL CUT KITS

Use Rail Cut kits when cutting a single rail kit into multiple parts for smaller railing sections, reducing costs and wasted material.

Level Black (#7622 BLK-PKG)

Stair Black (#7623 BLK-PKG)



END CAPS

Decorative option for covering, protecting, and finishing the Quick-Connect® Inset Fittings and Snug-Grip® Washer Nuts.

Dome style, 4 pack (#3372-PKG)

Crown style, 4 pack (#3373-PKG)

Chamfer style, 4 pack (#3374-PKG)

Black polyethylene, 10 pack (#7071-PKG)



CABLERRAIL KITS

Easy to maintain and easy to install with your aluminum Rail Kit. Available in various lengths to accommodate any job.

5-ft (#6205-PKG)

10-ft (#6210-PKG)

15-ft (#6215-PKG)

20-ft (#6220-PKG)

25-ft (#6225-PKG)

30-ft (#6230-PKG)

40-ft (#6240-PKG)

50-ft (#6250-PKG)



ISOLATION BUSHINGS

Use isolation bushings in pre-drilled CableRail holes when installing a railing in areas with harsher environments.

For Intermediate Posts
(#1100-INT-PKG)

For Threaded Terminal Posts
(#1100-TT-PKG)

For Quick-Connect® Posts
(#1100-QC-PKG)

For Intermediate Pickets (level)
(#1100-PK-PKG)

For Newel Termination Posts
(left and right)

(#1100-TTS-PKG & #1100-QC-PKG)

For Threaded Terminal Stair Posts
(#1100-TTS-PKG)

For Quick-Connect® Stair Posts
(#1100-QCS-PKG)

For Intermediate Pickets (stair)
(#1100-PKS-PKG)

For Single Corner, Intermediate Stair, and Newel Passthrough Posts
(#1100-SCIS-PKG)

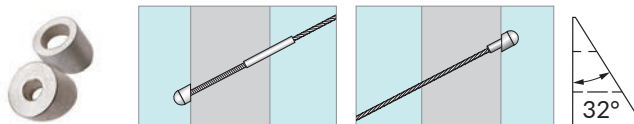

BEVELED WASHERS (stainless steel)

For providing a flat bearing surface when attaching cable fittings at angled stair terminations. A 32 degree angle fits most stair angles (26 and 37 degree angles available as special order).

4 pack (#3792-PKG) fits Quick-Connect® Inset Fitting

4 pack (#3799-PKG) fits Threaded Terminals

AVAILABLE AT:



www.feeneyinc.com
1-800-888-2418